

Forward vibratory plates – asphalt F92A Spare Parts List



TABLE OF CONTENT

1. Handle	4
1.1. Non vibrated handle cpl	5
1.1. Devibrated handle cpl	6
1.1. Non vibrated handle parts	7
1.1. Devibrated handle parts	8
2. Transport wheel	9
2.1. Transport wheel cpl	10
2.1. Transport wheel parts	11
3. Other machine parts	12
4. V-belt	13
5. Base plate 500mm	14
6. Polyurethane plate cpl	15
6.1. Polyurethane plate cpl	16
6.1. Polyurethane plate parts	17
7. Vibrations unit	18
7.1. Vibrations unit grease lubricate	19
7.1. Vibrations unit, parts grease lubricate	20
8. Water system	21
9. Engine	23
9.1. Engine kpl	24
9.1. Engine parts	25
9.2. Centrifugal clutch parts	26
9.2. Centrifugal clutch	
9.3. Mounting parts	28
10. Decals	29
11. Service kit	30

1. HANDLE



Pos	Label
1	Non vibrated handle cpl
1	Devibrated handle cpl
1	Non vibrated handle parts
1	Devibrated handle parts

1.1. NON VIBRATED HANDLE CPL

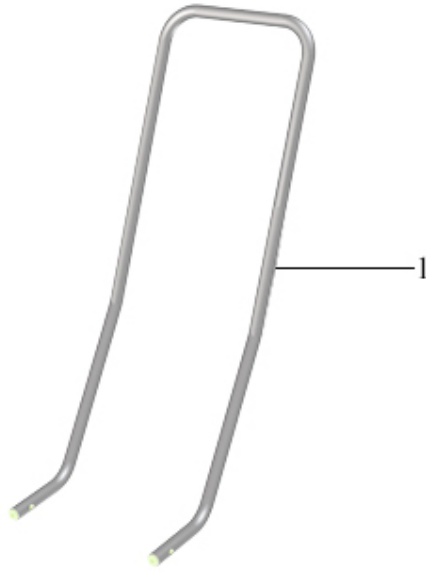

Pos	Part.No	Label	No
1	305370-01	HANDLE STD CPL	1

1.1. DEVIBRATED HANDLE CPL



Pos	Part.No	Label	No
1	305639-01	DEVIBRATED HANDLE CPL	1

1.1. NON VIBRATED HANDLE PARTS

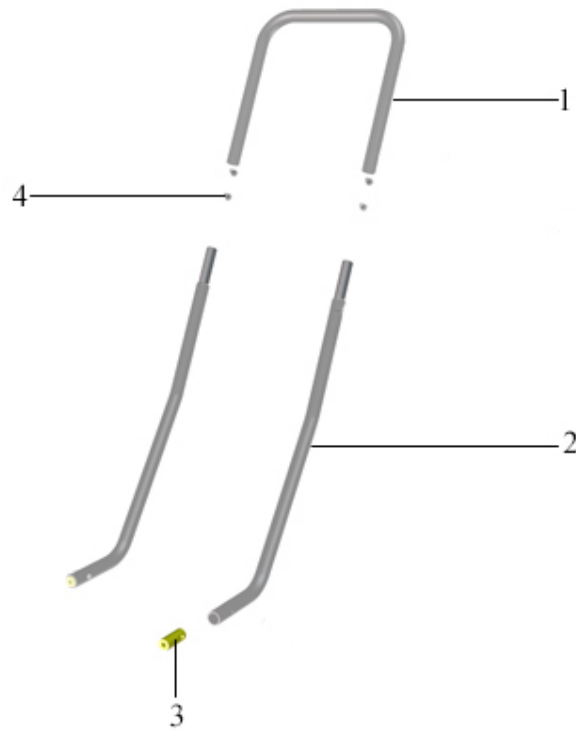

Pos	Part.No	Label	No
1	305648	HANDLE UPPER STANDARD	1
2	305371-01	HANDLE LOWER STANDARD	2
3	305015	PLUG	2
4	1001101	BOLT / K6S 8x12 10.9 fzb	4

1.1. DEVIBRATED HANDLE PARTS

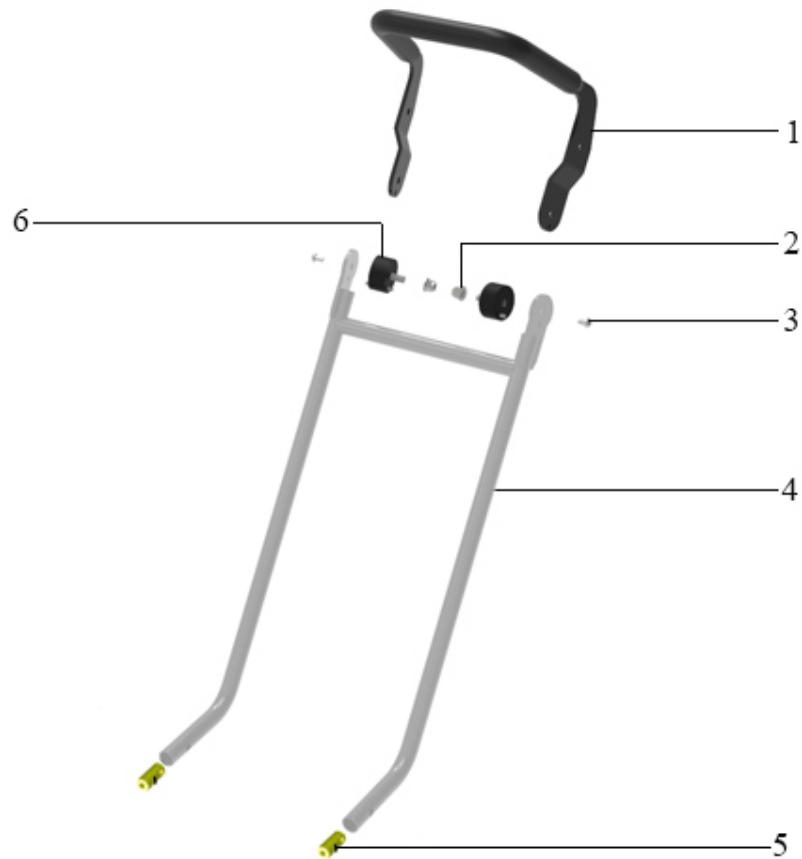

Pos	Part.No	Label	No
1	305633	HANDLE UPPER DEVIBRATED	1
2	100220	NUT / LOCKING M6MF M10	2
3	1001127	BOLT / M6SF 10x14 FZB	2
4	305636-01	HANDLE LOWER DEVIBRATED	1
5	305015	PLUG	2
6	100753	VIBRATION ISOLATOR	2

2. TRANSPORT WHEEL



Pos	Label
1	Transport wheel cpl
1	Transport wheel parts

2.1. TRANSPORT WHEEL CPL



Pos	Part.No	Label	No
1	305705	TRANSPORT WHEEL KIT	1

2.1. TRANSPORT WHEEL PARTS

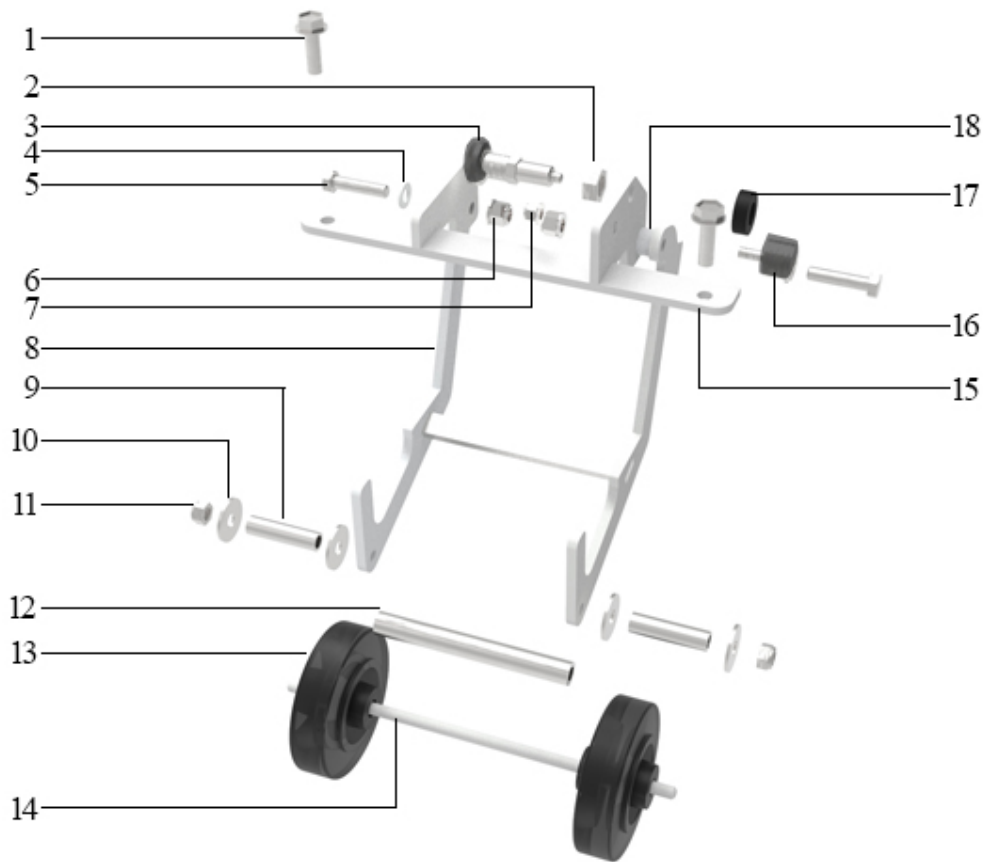

Pos	Part.No	Label	No
1	1001169	BOLT / M6SF 8X25 8.8 FZB	2
2	100228	NUT / M12x1,5	1
3	101127	LOCK BOLT ASSY	1
4	100301	WASHER / BRB 8,4x16 HB200 fzb	2
5	100150	BOLT / M6S 8x35 8.8 fzb	2
6	100221	NUT / LOCKING M6MF M8	2
7	100222	NUT / LOCKING M6MF M6	1
8	305706	BRACKET	1
9	101129	SLEEVE WHEEL SHAFT	2
10	100309	WASHER / SRKB 9x28x2 HB200 fzb	4
11	100221	NUT / LOCKING M6MF M8	2
12	305713	SPACER	1
13	101126	WHEEL	2
14	305712	STUD SCREW	1
15	305711	BRACKET	1
16	100747	IMPACT DAMPER	1
17	100354	WASHER / BRB 13x24x4 FZB	2
18	101128	SPACER	2

3. OTHER MACHINE PARTS

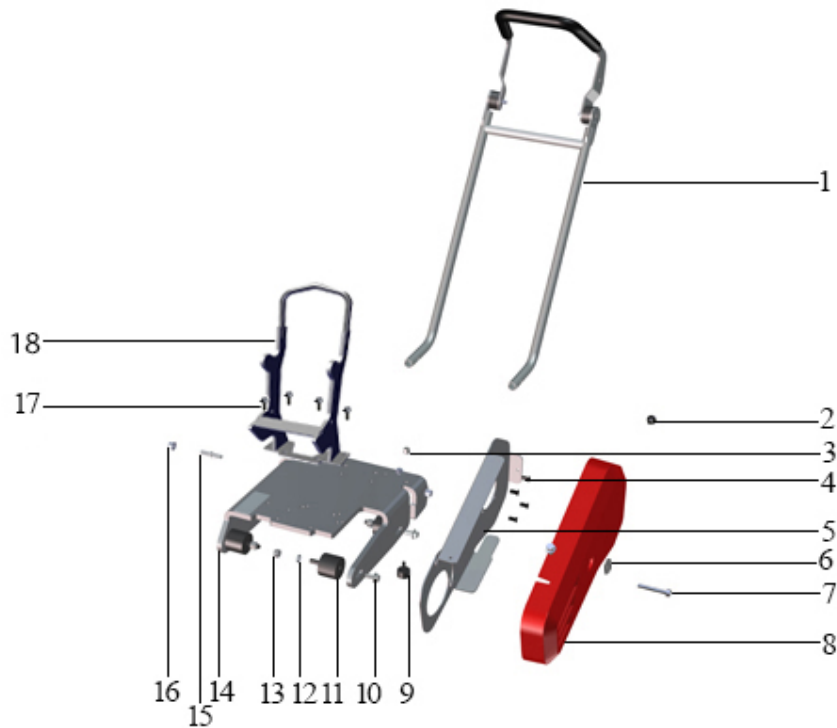

Pos	Part.No	Label	No
1	305639-01	DEVIBRATED HANDLE CPL	2
2	1001124	SCREW / M6SF 8x12 8.8 FZB	2
3	1001107	BOLT / M6SF 8x20 8.8 FZB	2
4	1001179	SCREW / MELC6S 8x16	4
5	305630	BELT GUARD-REAR	1
6	100309	WASHER / SRKB 9x28x2 HB200 fzb	1
7	1001331	SCREW / M6S 8X70 8.8 FZB	1
8	305620-01	BELT GUARD	1
9	100768	VIBRATIONS ISOLATOR	2
10	1001139	BOLT / M6SZ 10x20	4
11	100724	VIBRATION ISOLATOR	4
12	100360	WASHER / BRB 10X18 FZB HB 200	4
13	100251	NUT / MHM LOCKING 10 DIN 6924	4
14	305616	ENGINE PLATE	1
15	305316	PEG	2
16	100220	NUT / LOCKING M6MF M10	2
17	1001107	BOLT / M6SF 8x20 8.8 FZB	2
18	305660	LIFTING EYE	1

4. V-BELT

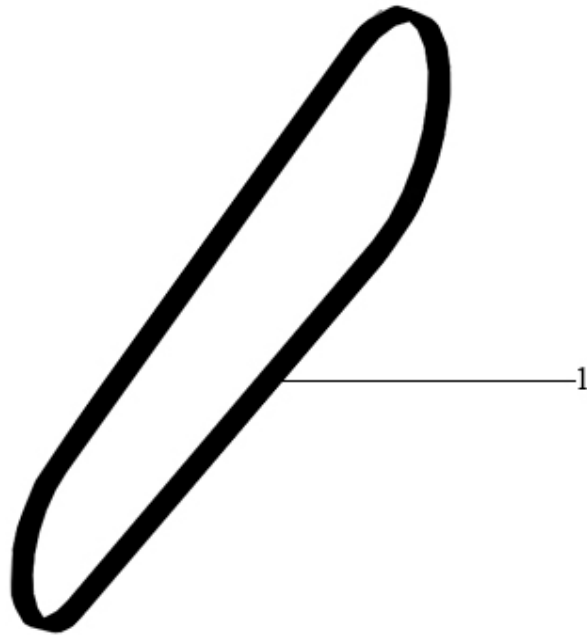

Pos	Part.No	Label	No
1	100848	V-BELT / XPA 907	1

5. BASE PLATE 500MM

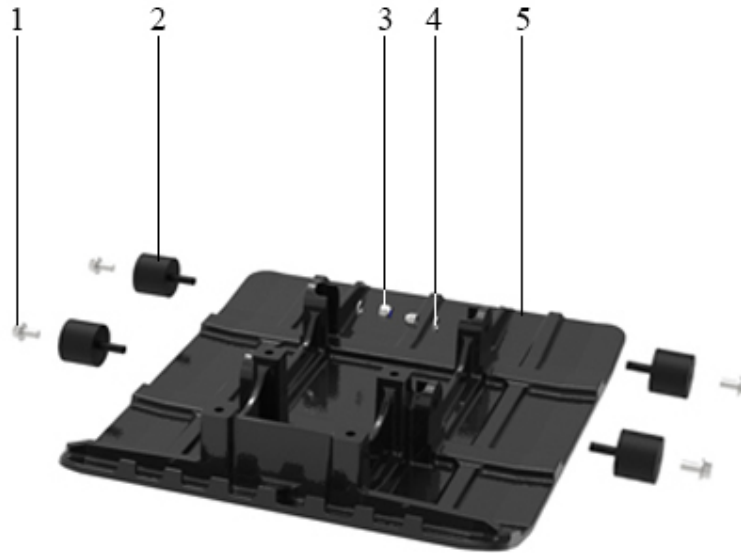

Pos	Part.No	Label	No
1	1001139	BOLT / M6SZ 10x20	4
2	100724	VIBRATION ISOLATOR	4
3	100251	NUT / MHM LOCKING 10 DIN 6924	4
4	100360	WASHER / BRB 10X18 FZB HB 200	4
5	305381	BASE PLATE 500	1

6. POLYURETHANE PLATE CPL

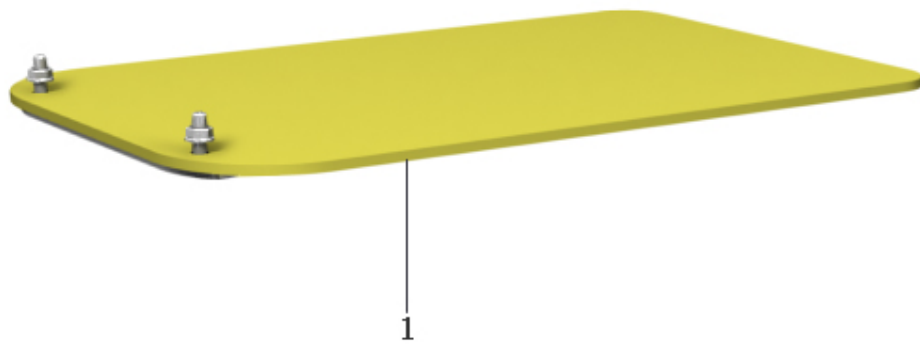

Pos	Label
1	Polyurethane plate cpl
1	Polyurethane plate parts

6.1. POLYURETHANE PLATE CPL

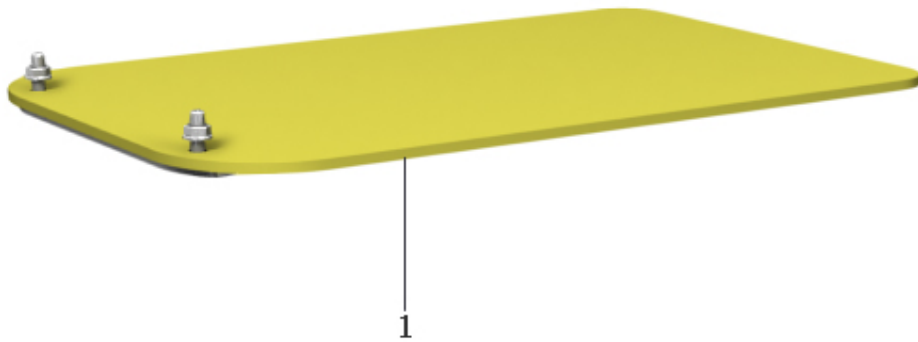

Pos	Part.No	Label	No
1	305645	POLYURETHANE PLATE CPL	1

6.1. POLYURETHANE PLATE PARTS

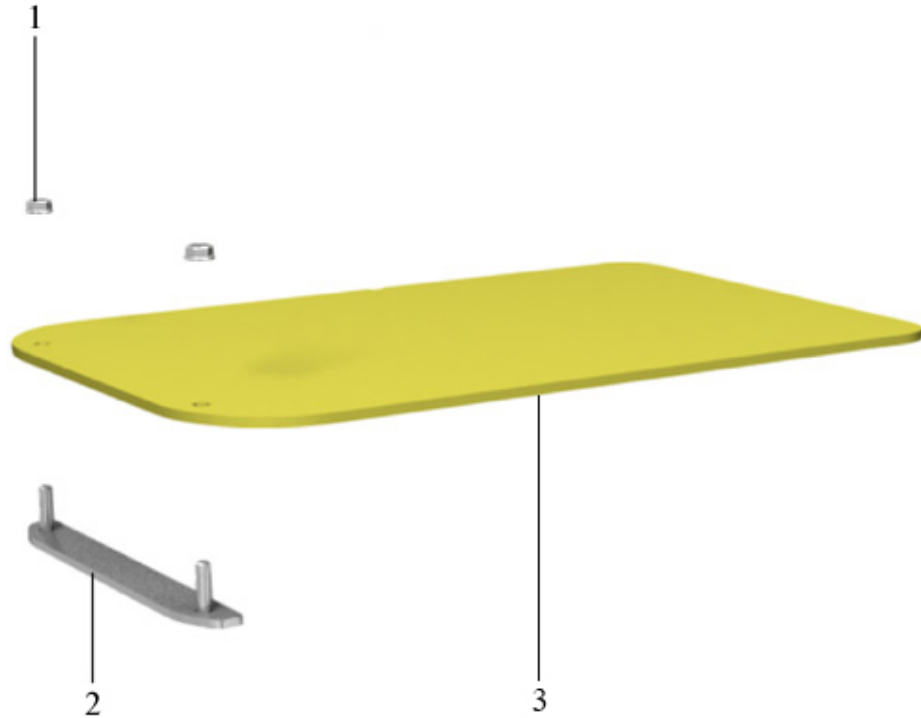

Pos	Part.No	Label	No
1	100220	NUT / LOCKING M6MF M10	2
2	305137	BRACKET	1
3	305646	POLYURETHANE PLATE	1

7. VIBRATIONS UNIT

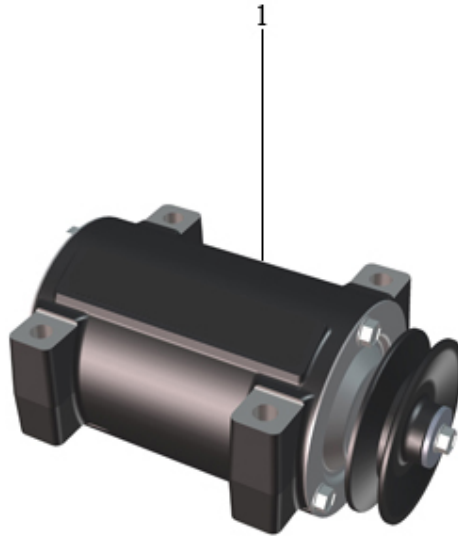

Pos	Label
1	Vibrations unit grease lubricate
1	Vibrations unit, parts grease lubricate

7.1. VIBRATIONS UNIT GREASE LUBRICATE

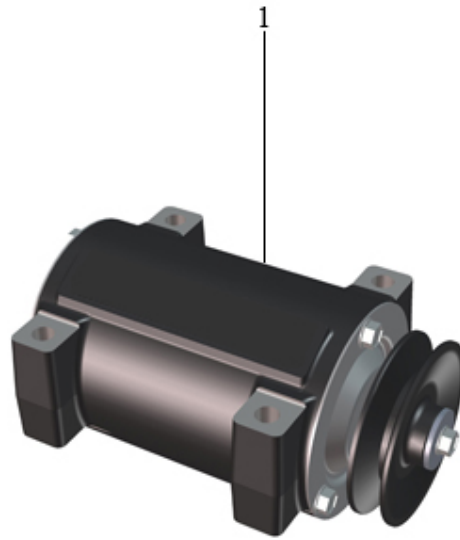

Pos	Part.No	Label	No
1	305655-01	VIBRATION UNIT CPL.	1

7.1. VIBRATIONS UNIT, PARTS GREASE LUBRICATE

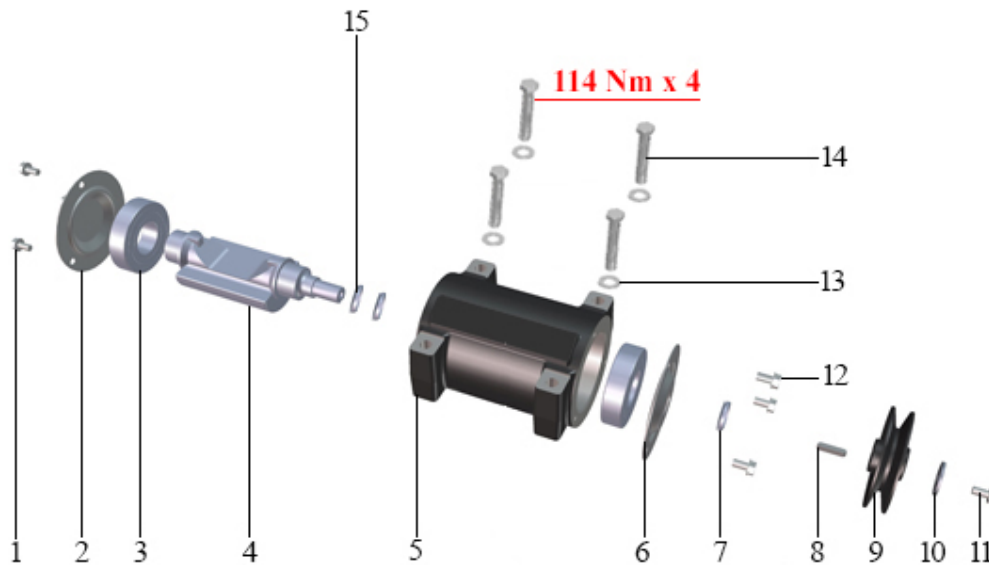

Pos	Part.No	Label	No
1	1001125	BOLT / M6SF 8x16 8.8 FZB	3
2	202129	LOCK	1
3	100528	BALL BEARING / 6308 VV-C3-AHQ	2
4	202131	ECCENTRIC	1
5	202128	HOUSING	1
6	202130	LOCK	1
7	100630	V-RING 25 VA	1
8	100400	FLAT KEY / RK 6x6x30 H9	1
9	202102	V-BELT PULLEY	1
10	100306	WASHER / SRKB 9x35x3 HB200 fzb	1
11	1001107	BOLT / M6SF 8x20 8.8 FZB	1
12	1001179	SCREW / MELC6S 8x16	3
13	100303	WASHER / BRB 13,0x24 HB200 fzb	4
14	1001274	BOLT / M6S 12x90 10.9	4
15	100327	WASHER / BRB 20x36 HB200 fzb	2

8. WATER SYSTEM

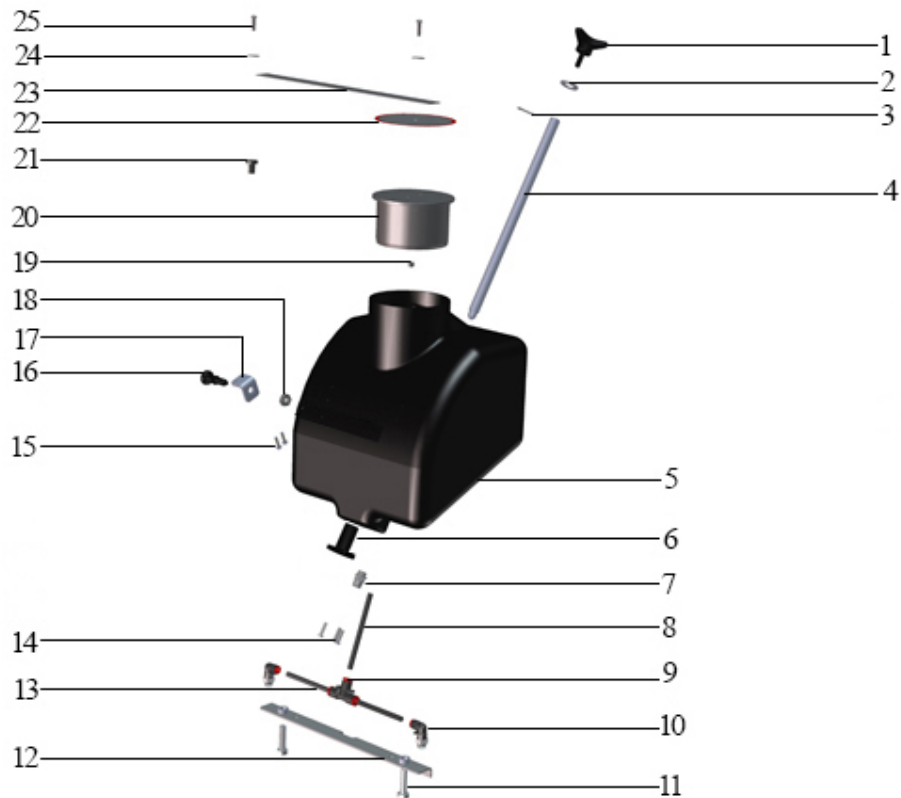

Pos	Part.No	Label	No
1	101151	KNOB	1
2	100304	WASHER / BRB 17,0x30 HB200 fzb	1
3	100491	SPLIT PIN	1
4	305343	ROD	1
5	305335	WATER TANK	1
6	305341	NOZZLE	1
7	1010062	ADAPTER ¼	1
8	1010064	HOSE	1
9	1010061	T-COUPLING	1
10	1010063	ADAPTER 90 ¼	2
11	100136	BOLT / M6S 10x40 8.8 fzb	2
12	305643	SPRINKLER CPL	1
13	1010064	HOSE	2
14	1001150	BOLT / DELTA PT 50x20	3
15	101183	SCREW / MELC6S 5x12 FZB 10.9	2
16	101127	LOCK BOLT ASSY	1
17	305347	BRACKET	1
18	100228	NUT / M12x1,5	1
19	100215	NUT / LOCKING5 BH8 fzb	1
20	101049	CAP-FUEL TANK	1
21	100468	WELL-NUT	1
22	305346	DECAL	1

23	305348	BELT	1
24	100346	WASHER / NB 6x19x1fzb	3
25	1001137	BOLT / MRX 5x20 A4	2

9. ENGINE

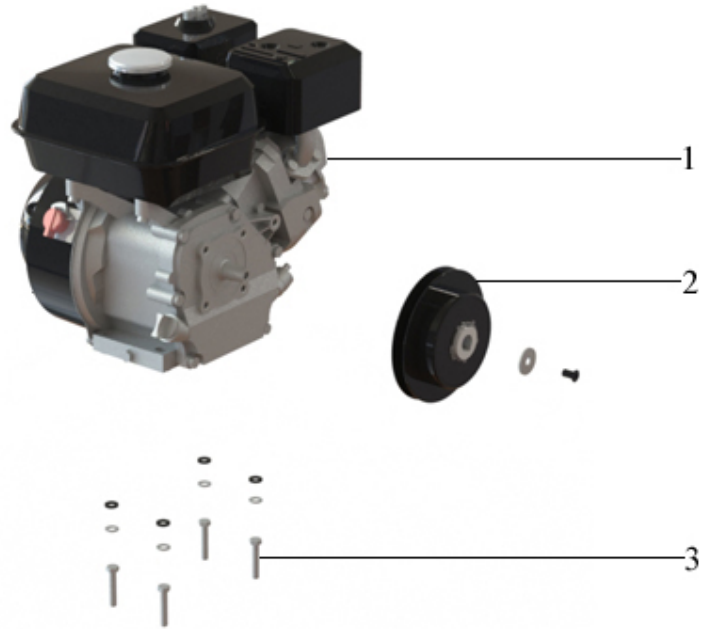

Pos	Label
1	Engine kpl
1	Engine parts
2	Centrifugal clutch parts
2	Centrifugal clutch
3	Mounting parts

9.1. ENGINE KPL

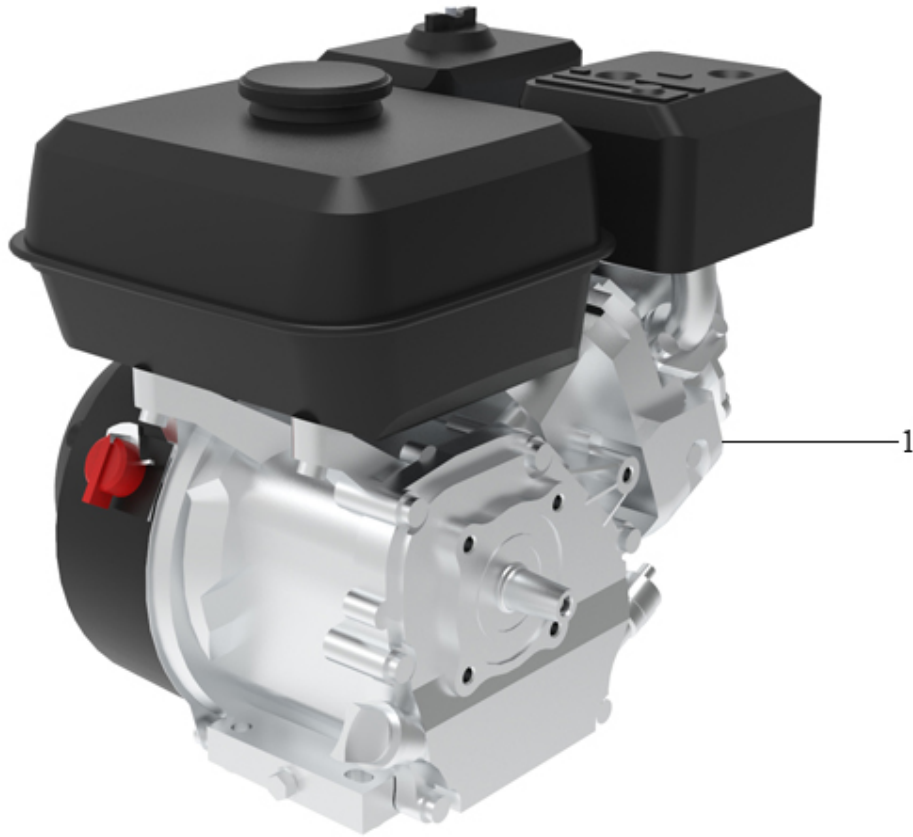

Pos	Part.No	Label	No
1	1018106	HONDA ENGINE GX 160H2	1

9.1. ENGINE PARTS

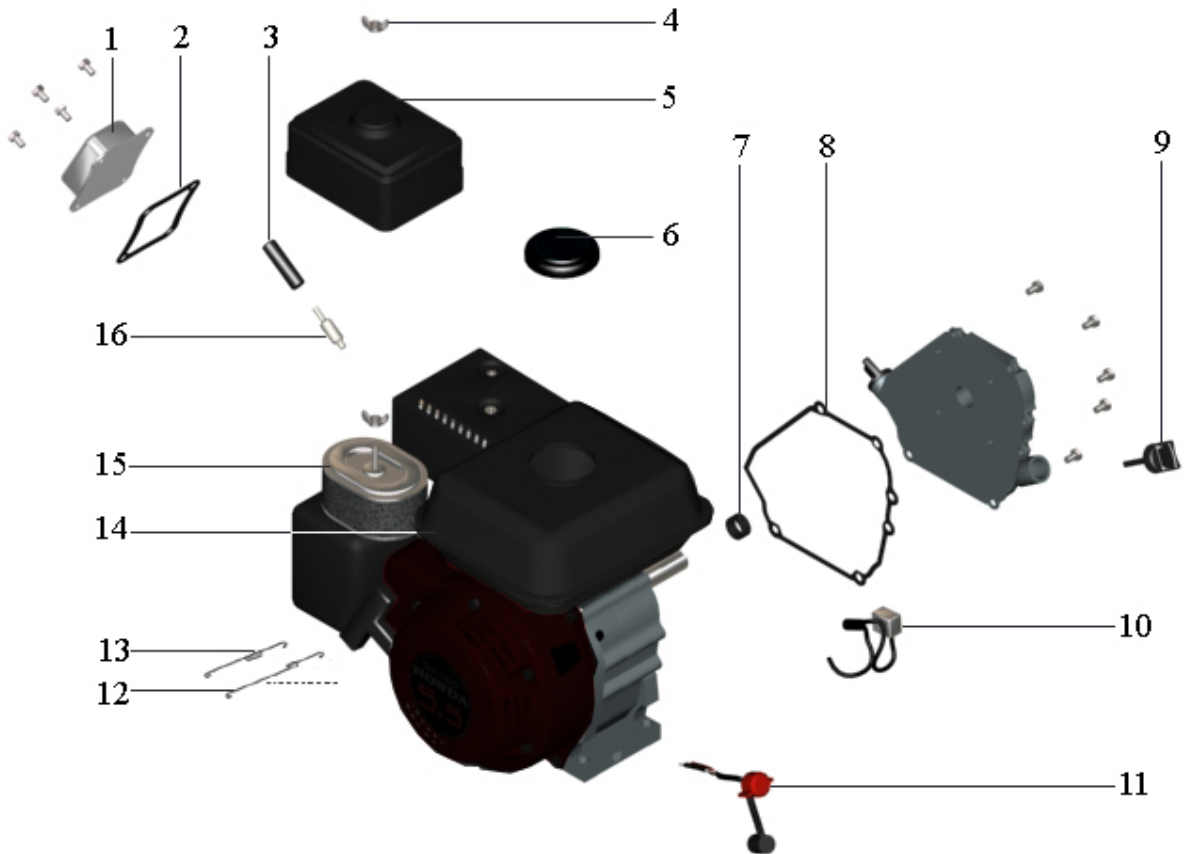

Pos	Part.No	Label	No
1	101857	BONNET ASSY, HEAD	1
2	101281	GASKET, BONNET	1
3	101277	BOOT-SPARK PLUG	1
4	101299	WING NUT, AIR FILTER	2
5	101751	COVER-AIR CLEANER	1
6	101275	CAP-FUEL TANK	1
7	101291	RADIAL SEAL	1
8	101273	SEAL, CRANKCASE	1
9	101280	DIP STICK	1
10	101760	CONTROL, OIL ALERT	1
11	101276	CIRCUIT BREAKER	1
12	101836	SPRING THROTTLE RETURN	1
13	101838	SPRING REGULATOR	1
14	102071	FUEL TANK BLACK	1
15	101210	AIR FILTER 70mm HIGH	1
16	101278	SPARK-PLUG	1

9.2. CENTRIFUGAL CLUTCH PARTS

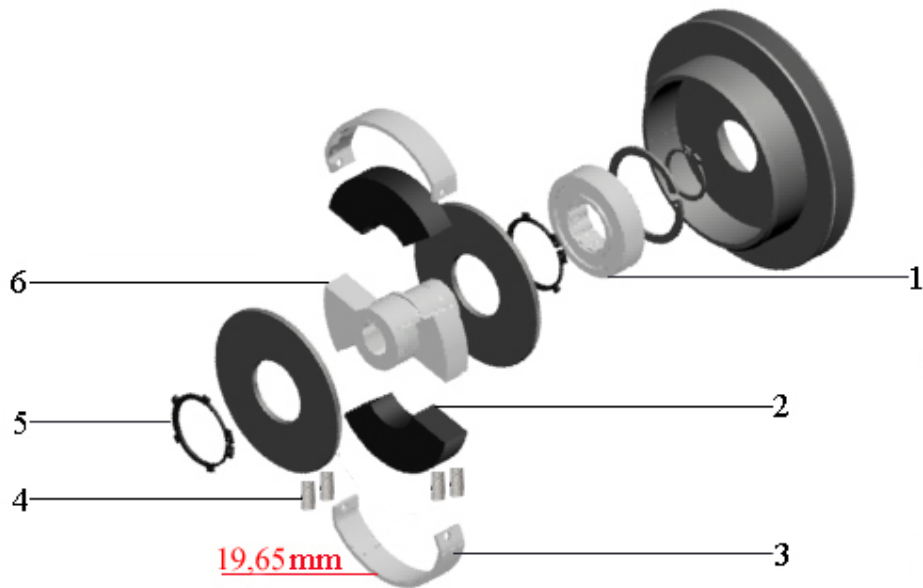

Pos	Part.No	Label	No
1	100930	BALL BEARING 6006 2RS	1
2	100864	WEIGHT	2
3	100811	CLUTCH LINING	2
4	100898	SPRING	4
5	100471	CIRCLIP / AK38	1
6	1008032	HUB	1

9.2. CENTRIFUGAL CLUTCH

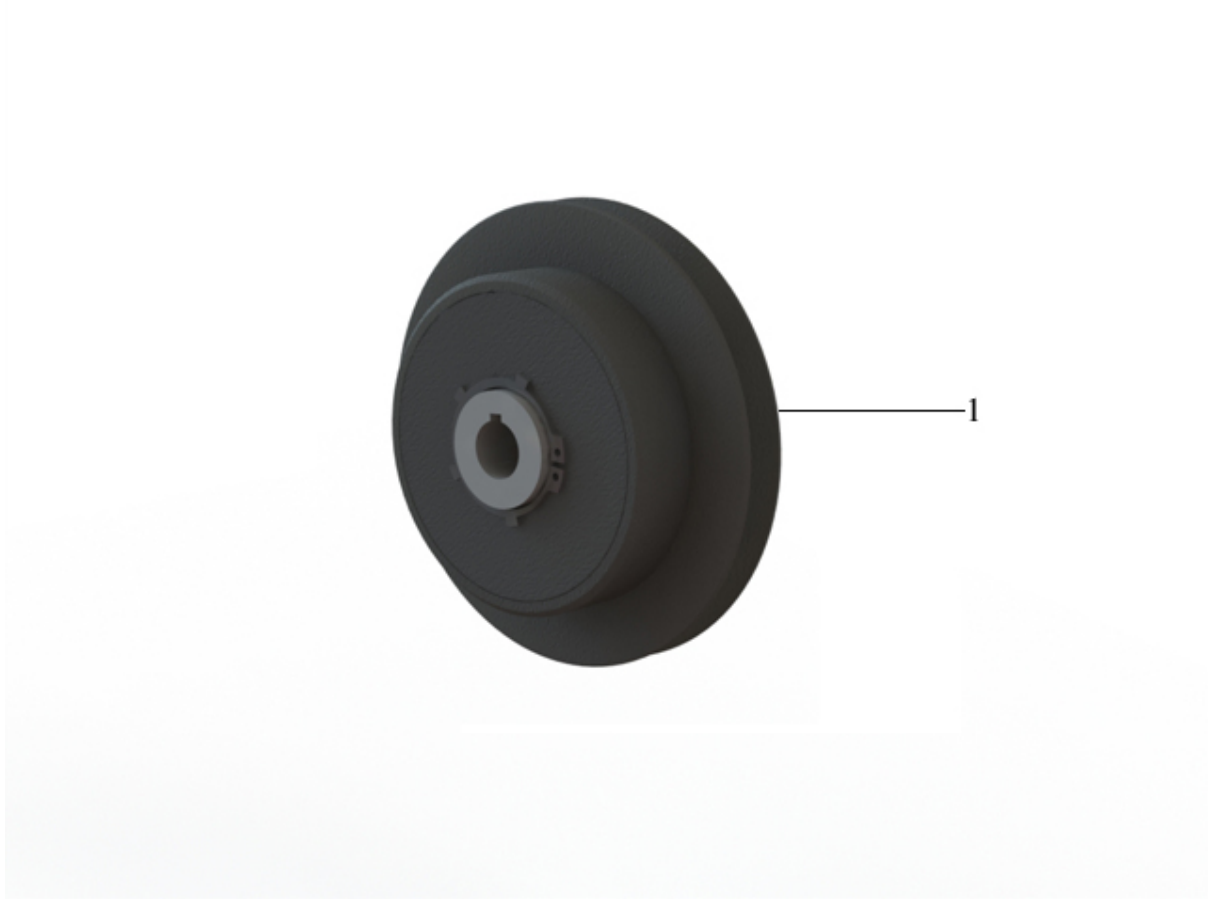

Pos	Part.No	Label	No
1	100896	CLUTCH	1

9.3. MOUNTING PARTS

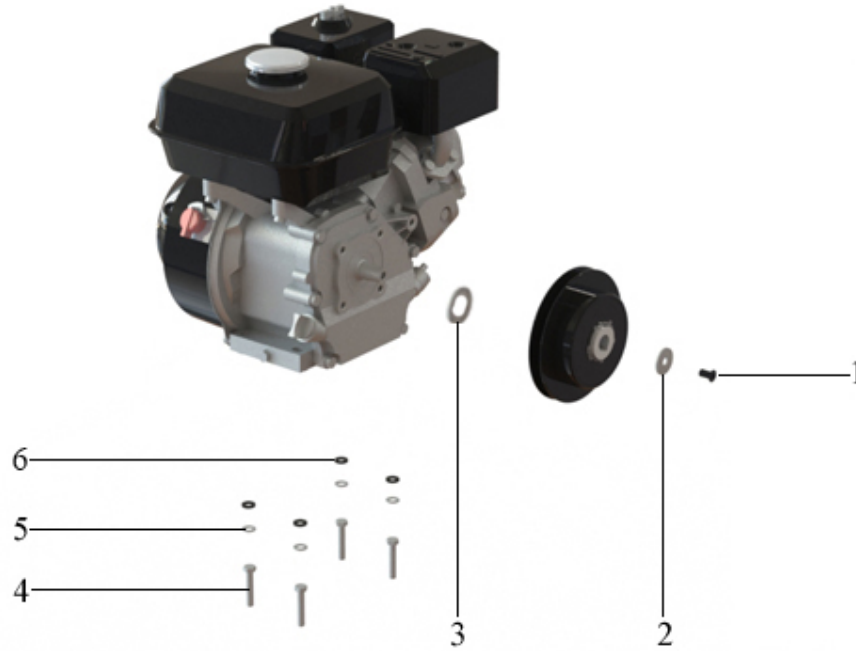

Pos	Part.No	Label	No
1	1001178	BOLT/ MELC6S 8x25 10.9	1
2	100356	WASHER / HS 8,4x29x2	1
3	202266	WASHER	1
4	100150	BOLT / M6S 8x35 8.8 fzb	4
5	100301	WASHER / BRB 8,4x16 HB200 fzb	4
6	100326	WASHER / HS 8	4

10. DECALS

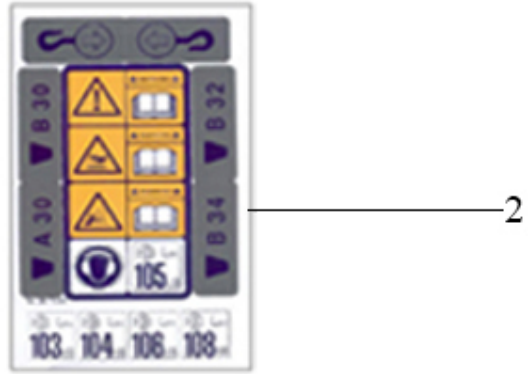

Pos	Part.No	Label	No
1	204071	DECAL SWEPAC	1
2	207065	DECAL	1
3	305689	F92A DECAL	2

11. SERVICE KIT

Pos	Part.No	Label	No
1	102113	SERVICE KIT SWEPAC F 80, F82, F92 HONDA	1
	-	Including parts:	
0	100848	V-BELT / XPA 907	1
0	101210	AIR FILTER 70mm HIGH	1
0	101278	SPARK-PLUG	1
	-		

